

# CVT10

## Fiber Converter

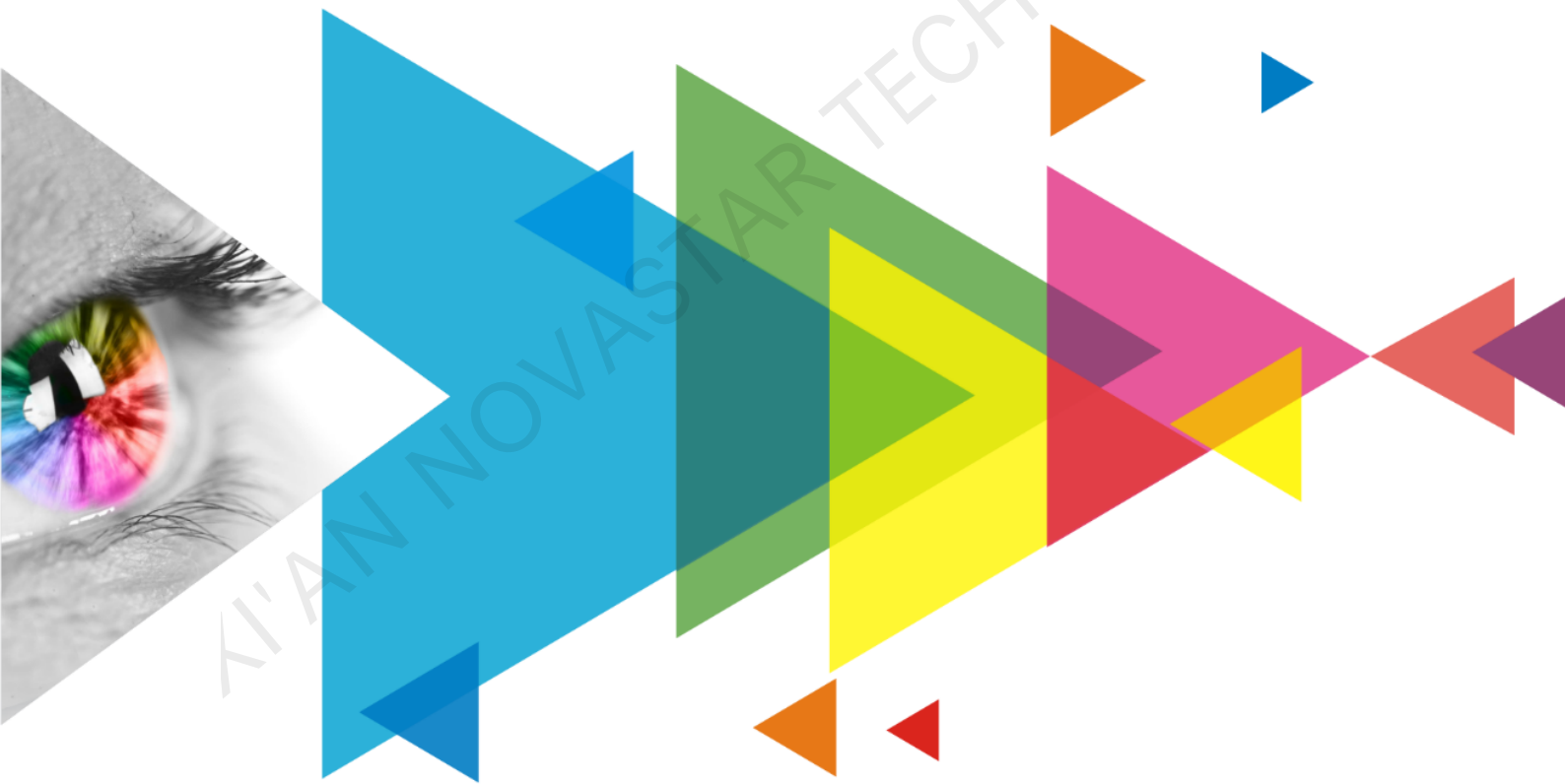

Specifications

## Change History

Document Version	Release Date	Description
V1.3.0	2022-04-25	<ul style="list-style-type: none"> <li>• Added the Notes and Cautions section.</li> <li>• Updated the certifications description.</li> <li>• Updated the rear panel diagram and connector descriptions.</li> <li>• Updated the dimensions diagram.</li> <li>• Updated the application diagrams.</li> </ul>
V1.2.2	2021-05-31	<ul style="list-style-type: none"> <li>• Added the PowerCON, installation and certification related description.</li> <li>• Updated the operating environment temperature.</li> </ul>
V1.2.1	2021-04-07	Deleted the Ethernet cable information from the packing list.
V1.2.0	2021-03-19	<ul style="list-style-type: none"> <li>• Added the RCM certification.</li> <li>• Updated the appearance diagram.</li> <li>• Updated the input current to 0.6 A.</li> </ul>
V1.1.3	2021-01-29	Optimized the Ethernet port description in Features.
V1.1.2	2021-01-08	Added the assembling effect diagram.
V1.1.1	2021-01-06	Updated the packing information.
V1.1.0	2020-12-31	<ul style="list-style-type: none"> <li>• Added the description of model segments.</li> <li>• Updated the rear panel appearance diagram.</li> <li>• Updated the dimensions diagram.</li> <li>• Updated the application diagrams.</li> <li>• Updated the humidity range.</li> <li>• Deleted the assembling description.</li> </ul>
V1.0.0	2020-12-04	First release

## Introduction

The CVT10 fiber converter offers a cost-effective way of conversion between optical signals and electrical signals for video sources to connect the sending card to the LED display. Delivering a full-duplex, efficient and stable data transmission that is not easily interfered with, this converter is ideal for long-distance transmission.

The CVT10 hardware design focuses on the practicality and convenience of the on-site installation. It can be mounted horizontally, in a suspended way, or rack mounted, which is easy, secure and reliable. For rack mounting, two CVT10 devices, or one CVT10 device and a connecting piece can be combined into one assembly that is 1U in width.

## Certifications

RoHS, FCC, CE, IC, RCM

**If the product does not have the relevant certifications required by the countries or regions where it is to be sold, please contact NovaStar to confirm or address the problem. Otherwise, the customer shall be responsible for the legal risks caused or NovaStar has the right to claim compensation.**

## Features

- Models include the CVT10-S (single-mode) and the CVT10-M (multi-mode).
- 2x optical ports with hot-swappable optical modules installed at the factory, bandwidth of each up to 10 Gbit/s
- 10x Gigabit Ethernet ports, bandwidth of each up to 1 Gbit/s
  - Fiber in and Ethernet out  
If the input device has 8 or 16 Ethernet ports, the first 8 Ethernet ports of the CVT10 are available.  
If the input device has 10 or 20 Ethernet ports, all the 10 Ethernet ports of the CVT10 are available. If Ethernet ports 9 and 10 are found unavailable, they will be available after upgrading in the future.
  - Ethernet in and fiber out  
All the 10 Ethernet ports of the CVT10 are available.
- 1x type-B USB control port

## Appearance

### Front Panel



Name	Description
USB	Type-B USB control port Connect to the control computer (NovaLCT V5.4.0 or later) for upgrading the CVT10 program, not for cascading.
PWR	Power indicator Always on: The power supply is normal.
STAT	Running indicator Flashing: The device is functioning normally.
OPT1/OPT2	Optical port indicators Always on: The optical fiber connection is normal.
1-10	Ethernet port indicators Always on: The Ethernet cable connection is normal.

Name	Description
MODE	The button to switch the device working mode The default mode is CVT mode. Only this mode is currently supported.
CVT/DIS	Working mode indicators Always on: The corresponding mode is selected. <ul style="list-style-type: none"> <li>• CVT: The fiber converter mode. OPT1 is the master port and OPT2 is the backup port.</li> <li>• DIS: Reserved</li> </ul>

**Rear Panel**

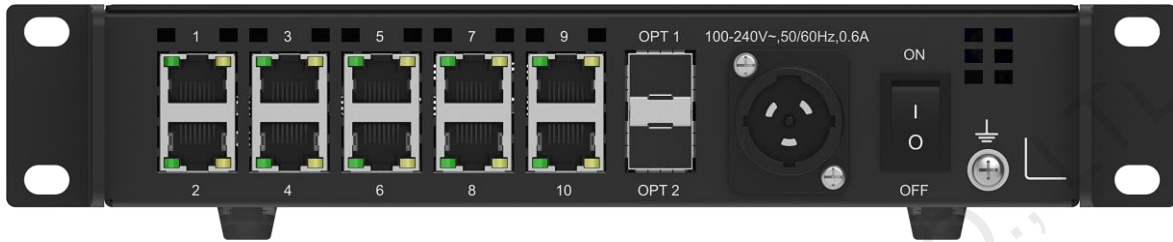

Name	Description				
100-240V~, 50/60Hz, 0.6A	Power input connector <ul style="list-style-type: none"> <li>• ON: Turn on the power.</li> <li>• OFF: Turn off the power.</li> </ul> For the PowerCON connector, users are not allowed to plug in hot. Pour le connecteur PowerCON, les utilisateurs ne sont pas autorisés à se connecter à chaud.				
OPT1/OPT2	10G optical ports <table border="1" style="width: 100%; border-collapse: collapse;"> <tbody> <tr> <td style="width: 50%; vertical-align: top;">                             CVT10-S optical module description:                             <ul style="list-style-type: none"> <li>• Hot swappable</li> <li>• Transmission rate: 9.95 Gbit/s to 11.3 Gbit/s</li> <li>• Wavelength: 1310 nm</li> <li>• Transmission distance: 10 km</li> </ul> </td> <td style="width: 50%; vertical-align: top;">                             CVT10-S optical fiber selection:                             <ul style="list-style-type: none"> <li>• Model: OS1/OS2</li> <li>• Transmission mode: Single-mode twin-core</li> <li>• Cable diameter: 9/125 μm</li> <li>• Connector type: LC</li> <li>• Insertion loss: ≤ 0.3 dB</li> <li>• Return loss: ≥ 45 dB</li> </ul> </td> </tr> <tr> <td style="vertical-align: top;">                             CVT10-M optical module description:                             <ul style="list-style-type: none"> <li>• Hot swappable</li> <li>• Transmission rate: 9.95 Gbit/s to 11.3 Gbit/s</li> <li>• Wavelength: 850 nm</li> <li>• Transmission distance: 300 m</li> </ul> </td> <td style="vertical-align: top;">                             CVT10-M optical fiber selection:                             <ul style="list-style-type: none"> <li>• Model: OM3/OM4</li> <li>• Transmission mode: Multi-mode twin-core</li> <li>• Cable diameter: 50/125 μm</li> <li>• Connector type: LC</li> <li>• Insertion loss: ≤ 0.2 dB</li> <li>• Return loss: ≥ 45 dB</li> </ul> </td> </tr> </tbody> </table>	CVT10-S optical module description: <ul style="list-style-type: none"> <li>• Hot swappable</li> <li>• Transmission rate: 9.95 Gbit/s to 11.3 Gbit/s</li> <li>• Wavelength: 1310 nm</li> <li>• Transmission distance: 10 km</li> </ul>	CVT10-S optical fiber selection: <ul style="list-style-type: none"> <li>• Model: OS1/OS2</li> <li>• Transmission mode: Single-mode twin-core</li> <li>• Cable diameter: 9/125 μm</li> <li>• Connector type: LC</li> <li>• Insertion loss: ≤ 0.3 dB</li> <li>• Return loss: ≥ 45 dB</li> </ul>	CVT10-M optical module description: <ul style="list-style-type: none"> <li>• Hot swappable</li> <li>• Transmission rate: 9.95 Gbit/s to 11.3 Gbit/s</li> <li>• Wavelength: 850 nm</li> <li>• Transmission distance: 300 m</li> </ul>	CVT10-M optical fiber selection: <ul style="list-style-type: none"> <li>• Model: OM3/OM4</li> <li>• Transmission mode: Multi-mode twin-core</li> <li>• Cable diameter: 50/125 μm</li> <li>• Connector type: LC</li> <li>• Insertion loss: ≤ 0.2 dB</li> <li>• Return loss: ≥ 45 dB</li> </ul>
CVT10-S optical module description: <ul style="list-style-type: none"> <li>• Hot swappable</li> <li>• Transmission rate: 9.95 Gbit/s to 11.3 Gbit/s</li> <li>• Wavelength: 1310 nm</li> <li>• Transmission distance: 10 km</li> </ul>	CVT10-S optical fiber selection: <ul style="list-style-type: none"> <li>• Model: OS1/OS2</li> <li>• Transmission mode: Single-mode twin-core</li> <li>• Cable diameter: 9/125 μm</li> <li>• Connector type: LC</li> <li>• Insertion loss: ≤ 0.3 dB</li> <li>• Return loss: ≥ 45 dB</li> </ul>				
CVT10-M optical module description: <ul style="list-style-type: none"> <li>• Hot swappable</li> <li>• Transmission rate: 9.95 Gbit/s to 11.3 Gbit/s</li> <li>• Wavelength: 850 nm</li> <li>• Transmission distance: 300 m</li> </ul>	CVT10-M optical fiber selection: <ul style="list-style-type: none"> <li>• Model: OM3/OM4</li> <li>• Transmission mode: Multi-mode twin-core</li> <li>• Cable diameter: 50/125 μm</li> <li>• Connector type: LC</li> <li>• Insertion loss: ≤ 0.2 dB</li> <li>• Return loss: ≥ 45 dB</li> </ul>				
1-10	Gigabit Ethernet ports				

## Dimensions

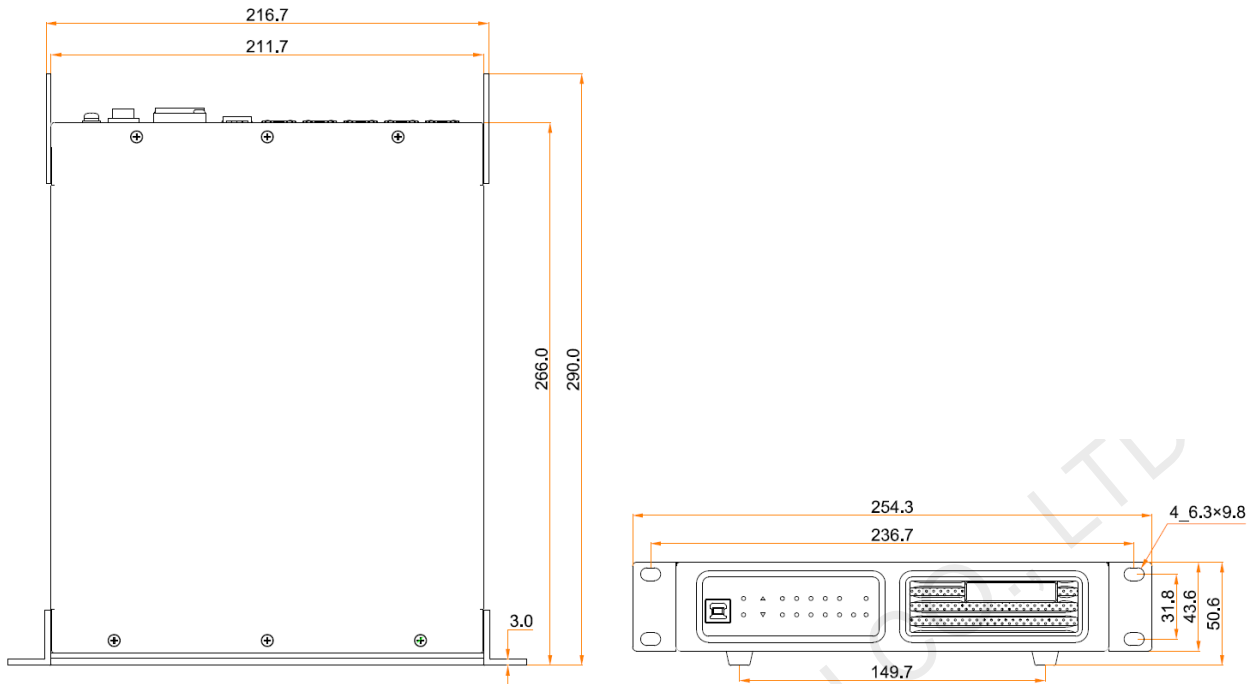

Tolerance:  $\pm 0.3$  Unit: mm

## Applications

The CVT10 is used for long-distance data transmission. Users can decide a connection method based on whether the sending card has optical ports.

### The Sending Card Has Optical Ports

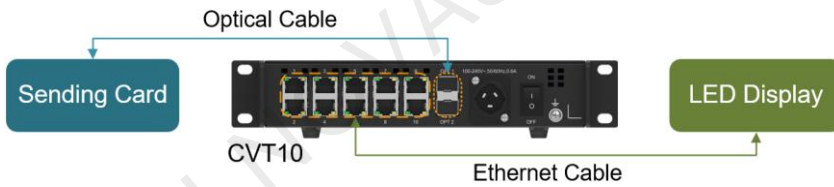

### The Sending Card Has No Optical Ports

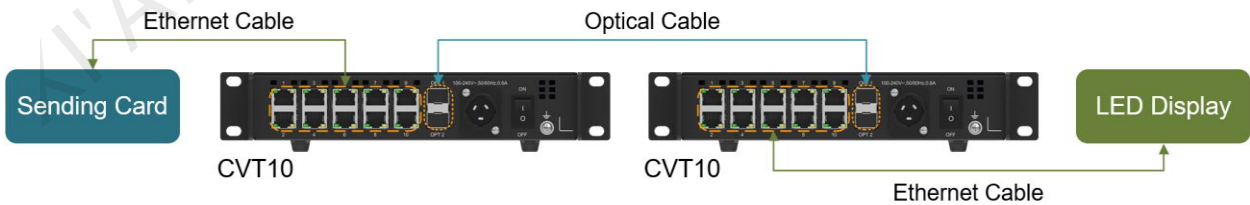

## Assembling Effect Diagram

A single CVT10 device is half-1U in width. Two CVT10 devices, or one CVT10 device and a connecting piece can be combined into one assembly that is 1U in width.

## Assembly of Two CVT10

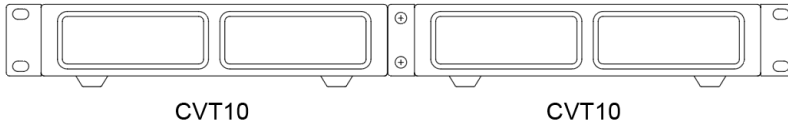

## Assembly of a CVT10 and a Connecting Piece

The connecting piece can be assembled to the right or left side of the CVT10.

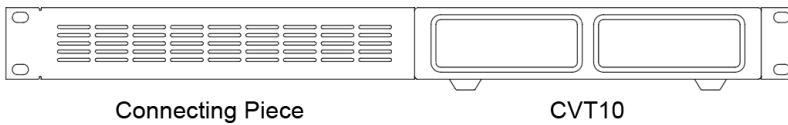
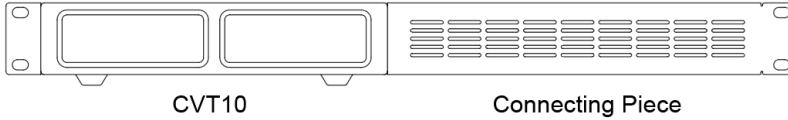

## Specifications

Electrical Specifications	Power supply	100-240V~, 50/60Hz, 0.6A
	Rated power consumption	22 W
Operating Environment	Temperature	-20°C to +55°C
	Humidity	10% RH to 80% RH, non-condensing
Storage Environment	Temperature	-20°C to +70°C
	Humidity	10% RH to 95% RH, non-condensing
Physical Specifications	Dimensions	254.3 mm × 50.6 mm × 290.0 mm
	Net weight	2.1 kg Note: It is the weight of a single product only.
	Gross weight	3.1 kg Note: It is the total weight of the product, accessories and packing materials packed according to the packing specifications.
Packing Information	Outer box	387.0 mm × 173.0 mm × 359.0 mm, kraft paper box
	Packing box	362.0 mm × 141.0 mm × 331.0 mm, kraft paper box
	Accessories	<ul style="list-style-type: none"> <li>• 1x Power cord, 1x USB cable</li> <li>• 1x Supporting bracket A (with nuts), 1x Supporting bracket B (without nuts)</li> <li>• 1x Connecting piece</li> <li>• 12x M3*8 screws</li> <li>• 1x Assembling diagram</li> <li>• 1x Certificate of Approval</li> </ul>

The amount of power consumption may vary depending on factors such as product settings, usage, and environment.

## Notes and Cautions

### Notes for Installation

Caution: The equipment must be installed in a restricted access location.

Attention: L'équipement doit être installé dans un endroit à accès restreint.

When the product needs to be installed on the rack, 4 screws at least M5\*12 should be used to fix it. The rack for installation shall bear at least 9kg weight.

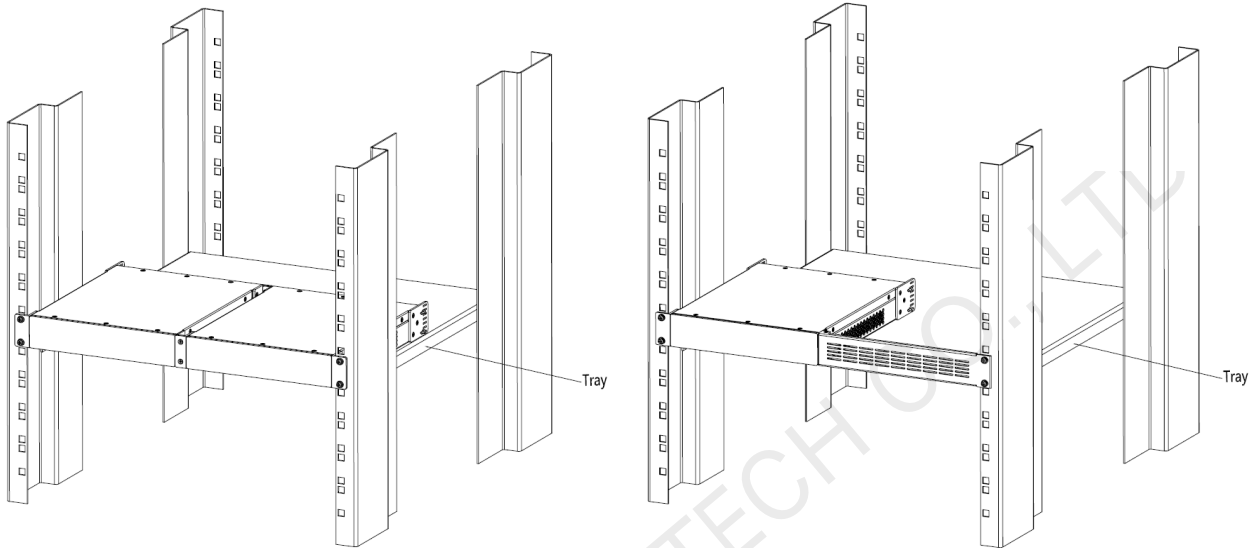

- Elevated Operating Ambient - If installed in a closed or multi-unit rack assembly, the operating ambient temperature of the rack environment may be greater than room ambient. Therefore, consideration should be given to installing the equipment in an environment compatible with the maximum ambient temperature (T<sub>ma</sub>) specified by the manufacturer.
- Reduced Air Flow – Installation of the equipment in a rack should be such that the amount of air flow required for safe operation of the equipment is not compromised.
- Mechanical Loading – Mounting of the equipment in the rack should be such that a hazardous condition is not achieved due to uneven mechanical loading.
- Circuit Overloading – Consideration should be given to the connection of the equipment to the supply circuit and the effect that overloading of the circuits might have on overcurrent protection and supply wiring. Appropriate consideration of equipment nameplate ratings should be used when addressing this concern.
- Reliable Earthing – Reliable earthing of rack-mounted equipment should be maintained. Particular attention should be given to supply connections other than direct connections to the branch circuit (e.g. use of power strips).

### FCC Caution

Any changes or modifications not expressly approved by the party responsible for compliance could void the user's authority to operate the equipment.

This device complies with part 15 of the FCC Rules. Operation is subject to the following two conditions: (1) This device may not cause harmful interference, and (2) this device must accept any interference received, including interference that may cause undesired operation.

Note: This equipment has been tested and found to comply with the limits for a Class A digital device, pursuant to part 15 of the FCC Rules. These limits are designed to provide reasonable protection against harmful interference when the equipment is operated in a commercial environment. This equipment generates, uses, and can radiate radio frequency energy and, if not installed and used in accordance with the instruction manual, may cause harmful

interference to radio communications. Operation of this equipment in a residential area is likely to cause harmful interference in which case the user will be required to correct the interference at his own expense.

### Others

This is Class A product. In a domestic environment, this product may cause radio interference in which case the user may be required to take adequate measures.

XI'AN NOVASTAR TECH CO., LTD



**Copyright © 2022 Xi'an NovaStar Tech Co., Ltd. All Rights Reserved.**

No part of this document may be copied, reproduced, extracted or transmitted in any form or by any means without the prior written consent of Xi'an NovaStar Tech Co., Ltd.

#### **Trademark**

**NOVA STAR** is a trademark of Xi'an NovaStar Tech Co., Ltd.

#### **Statement**

Thank you for choosing NovaStar's product. This document is intended to help you understand and use the product. For accuracy and reliability, NovaStar may make improvements and/or changes to this document at any time and without notice. If you experience any problems in use or have any suggestions, please contact us via the contact information given in this document. We will do our best to solve any issues, as well as evaluate and implement any suggestions.

**Official website**  
[www.novastar.tech](http://www.novastar.tech)

**Technical support**  
[support@novastar.tech](mailto:support@novastar.tech)